

Varenummer: 207321M121414st  
Beskrivelse: E+G Pasbolt  
GN 732.1-M12-14-14-ST

## Mål

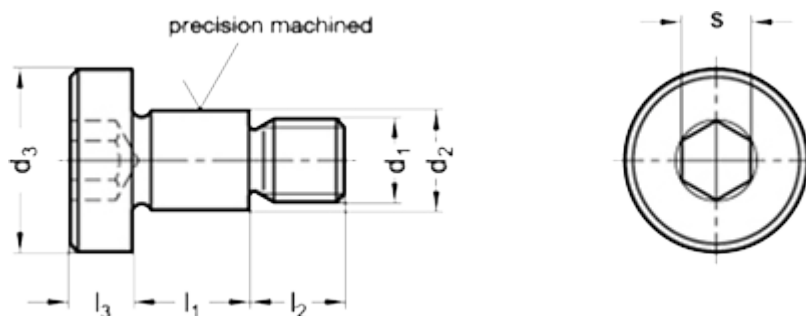

### Application example



d1	= M 12
d2	= 14 -0.05/-0.08
d3	= 22
$l_1 +0.20/+0.13$	= 14
$l_2$	= 16
$l_3$	= 8
s	= 8
Vægt i (g)	= 30